

Lead Post, Jamb Moulding & Handle

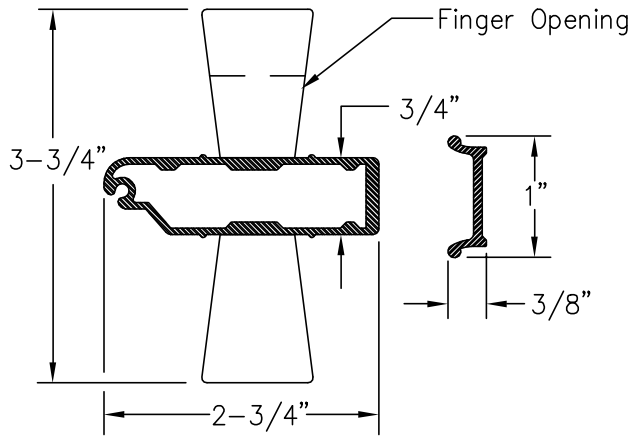

Doors without keylocks.

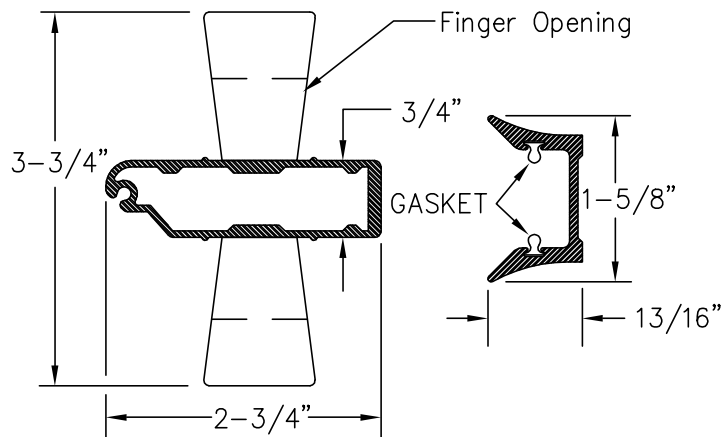

Doors with keylocks.

CAD LPJM-440

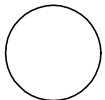

LEAD POST, JAMB MOULDINGS & HANDLE – MODEL 440